

- Low Noise: 10 $\mu\text{g}/\text{Hz}$ Typical for $\pm 2\text{g}$ Full Scale Versions
- -55 to +125°C Operating Temperature Range
- Acceleration and Vibration Sensing
- Excellent Long-Term Stability
- Flexible +8 to +32 VDC Power
- $\pm 4\text{V}$ Differential Output or 0.5V to 4.5V Single Ended Output
- Responds to frequencies from zero (DC) to 2000+ Hz
- Low Impedance Outputs Support up to 2000 Feet of Cable
- Simple Four (4) or Eight (8) Wire Connection
- Rugged, Hermetic Titanium Case Capable of IP67
- Fully Calibrated and Serialized for Traceability

AVAILABLE G-RANGES	
FULL SCALE ACCELERATION	MODEL SUFFIX
$\pm 2\text{ g}$	-002
$\pm 5\text{ g}$	-005
$\pm 10\text{ g}$	-010
$\pm 25\text{ g}$	-025
$\pm 50\text{ g}$	-050
$\pm 100\text{ g}$	-100
$\pm 200\text{ g}$	-200
$\pm 400\text{ g}$	-400

PREMIUM HERMETIC ACCELEROMETER MODELS 2240 AND 2480



Models 2240 and 2480 Specialty Hermetic MEMS Variable Capacitive DC Accelerometers from Silicon Designs (SDI) are low-cost, integrated plug-and-play measurement devices suitable for a wide array of demanding applications. Both models provide enhanced performance over temperature in zero to medium frequency applications experiencing large or rapid temperature variations or maintaining hot or cold extremes for extended periods of time.



The SDI Models 2240 and 2480 contain a single or three orthogonally mounted, Premium accelerometer LCCs, making them even less sensitive to temperature changes and gradients from -55 to +125°C and greatly reducing bias and scale factor temperature shifts for premium performance. Their enhanced, temperature compensated, proprietary SDI Model 1522 accelerometer LCC chips are individually tested, calibrated and verified in a climate chamber. Both the 2240 and 2480 come with an initial calibration report featuring additional information about the linearity, output, phase, and frequency response as tested for each unit.

SDI 2240 and 2480 accelerometers are packaged in rugged, hermetically-sealed, titanium cases, and connectors allow for customized cable lengths and easy repositioning. Onboard voltage regulation and an internal voltage reference eliminate the need for precision power supplies. The cases are rated IP 67; the connector is rated IP 61 and can meet IP 67 when sealed with a boot, sleeve, or heat shrink. The case is easily mounted via two screws, adhesive, or by attaching a magnet.

ZERO (DC) TO MEDIUM FREQUENCY APPLICATIONS



PERFORMANCE BY G RANGE

INPUT RANGE	SENSITIVITY, DIFFERENTIAL	FREQUENCY RESPONSE (TYPICAL, 5%)	FREQUENCY RESPONSE (TYPICAL, 3 DB)	FREQUENCY RESPONSE (MINIMUM, 3 DB)	OUTPUT NOISE, DIFFERENTIAL (RMS, TYPICAL)	MAX. MECHANICAL SHOCK (0.1 MS)
g	mV/g	Hz	Hz	Hz	$\mu\text{g}/(\text{root Hz})$	g (peak)
± 2	2000	0 - 250	0 - 525	0 - 300	10	2000
± 5	800	0 - 400	0 - 800	0 - 420	15	
± 10	400	0 - 700	0 - 1100	0 - 660	23	
± 25	160	0 - 1300	0 - 1750	0 - 1050	38	
± 50	80	0 - 1600	0 - 2100	0 - 1400	60	5000
± 100	40	0 - 1700	0 - 3000	0 - 1700	121	
± 200	20	0 - 1900	0 - 3600	0 - 2100	243	
± 400	10	0 - 2000	0 - 4200	0 - 2400	475	

By Version: $V_{DD}=V_R=5.0\text{ VDC}$, $T_C=25^\circ\text{C}$

Single ended sensitivity is half of values shown.

SPECIFICATIONS SUBJECT TO CHANGE WITHOUT NOTICE

PERFORMANCE - ALL VERSIONS

 All Models: Unless otherwise specified, $V_s=+8$ to $+32$ VDC, $T_C=25^\circ\text{C}$, Differential Mode. Span = $\pm g$ range = 8000 mV.

PARAMETER	MIN	TYP	MAX	UNITS
Bias Calibration Error (%)		0.25	0.6	\pm % of span
Bias Calibration Error (mV)		25	60	\pm mV
Scale Factor Calibration Error ¹		0.5	1.25	\pm %
Non-Linearity (-90 to +90% of span) ¹		0.15	0.5	\pm % of span
Bias Temperature Shift (Coefficient)	-100	0	+100	(PPM of span)/ $^\circ\text{C}$
Scale Factor Temperature Shift (Coefficient)	-150	0	+50	PPM/ $^\circ\text{C}$
Cross Axis Sensitivity		2	3	\pm %
Power Supply Rejection Ratio	50	>65		dB
Output Impedance		1		Ω
Output Common Mode Voltage		2.5		VDC
Operating Voltage	8		32	VDC
Operating Current (AOP & AON open, 2240/2480)	6/19	7/23	12/27	mA DC
Mass 2240 / 2480		15 / 25		grams
Operating Temperature	-55		+125	$^\circ\text{C}$

 Note 1: For 2g thru 50g only; 100g and greater versions are tested and specified from -65 to $+65g$.

NOTICE: Stresses greater than those listed may cause permanent damage to the device. These are maximum stress ratings only. Functional operation of the device at or above these conditions is not implied.

BIAS & SCALE FACTOR TEMPERATURE SHIFT EXPLAINED

Every accelerometer has a bias and scale factor temperature coefficient, meaning the output shifts slightly due to temperature changes. Many applications operate within a relatively small temperature band or at room temperature, and therefore rarely encounter interference from the bias or scale factor temperature shifts. These customers are ideal candidates for SDI's Low-Cost accelerometer modules.

For applications experiencing larger temperature variations (i.e. exposure to engine temperatures or arctic testing) SDI suggests the upgraded Premium accelerometer modules. These have enhanced, temperature compensated, proprietary SDI Model 1522 accelerometer chips, which are individually tested, calibrated and verified in a climate chamber to provide the most accuracy and come with an initial calibration certificate.

Bias	The accelerometer output with no acceleration present. For SDI's differential output analog accelerometers, it is a signed quantity that is expressed in terms of either g or output volts and is ideally equal to zero g or zero volts.
Scale Factor	The ratio of the change in output to a unit change in the input acceleration expressed in millivolts per g (mV/g). Since the output of most accelerometers is slightly non-linear, the scale factor value is defined as the slope of the least-squares-fit line to the acceleration input vs output curve. SDI measures over the range of -90% to +90% of full scale or from -65g to +65g, whichever is smaller.
Bias Temperature Shift (Coefficient)	The amount of bias shift to expect with a change in temperature expressed as PPM of span per $^\circ\text{C}$. For example, the percent of span bias shift that would occur for a 25g full scale device with a ± 200 PPM of span per $^\circ\text{C}$ rating and a 55 $^\circ\text{C}$ rise from room temperature would be: $\pm 200 / 1,000,000 \times (80\text{C} - 25\text{C}) \times 100\%$ of span = $\pm 1.1\%$ of span. The g shift would be $\pm 1.1\%$ of 50g = 0.55 g. This error in terms of output voltage for a 25 g analog accelerometer would be $\pm 1.1\%$ of span = $\pm 1.1\%$ of 8 V = 88 mV.
Scale Factor Temperature Shift (Coefficient)	The amount of scale factor shift to expect with a change in temperature expressed as PPM per $^\circ\text{C}$. For example, the percent shift in scale factor that would occur for a device with a +200 PPM per $^\circ\text{C}$ rating and a 60 $^\circ\text{C}$ rise from room temperature would be: $200 / 1,000,000 \times (85\text{C} - 25\text{C}) \times 100\%$ = +1.2%. For an analog 10g device, the scale factor would rise from its nominal (8 V)/(20 g) = 400 mV/g at +25C to 400 mV/g + 1.2% = 404.8 mV/g.

SPECIFICATIONS SUBJECT TO CHANGE WITHOUT NOTICE

OPERATION

SDI Models 2240 and 2480 MEMS Specialty Hermetic Variable Capacitive Accelerometers provide optimal performance when they are connected to instrumentation in a differential configuration using both the AOP and AON output signals, but they also support single ended operation for complete flexibility.

These accelerometers produce differential analog output voltage pairs (AON & AOP) which vary with acceleration. The signal outputs are fully differential about a common mode voltage of approximately 2.5 volts. At zero acceleration, the output differential voltage is nominally 0 volts DC; at \pm full scale acceleration, the output is ± 4 volts DC, respectively, as shown in the figure (below). The output scale factor is independent from the supply voltage of +8 to +32 volts.

When a differential connection is not possible, SDI recommends connecting the accelerometer to instrumentation in single ended mode by connecting AOP and GND to the instrumentation and leaving AON disconnected. Keep in mind that the signal to noise ratio is reduced by half for a single-ended vs. a differential connection.

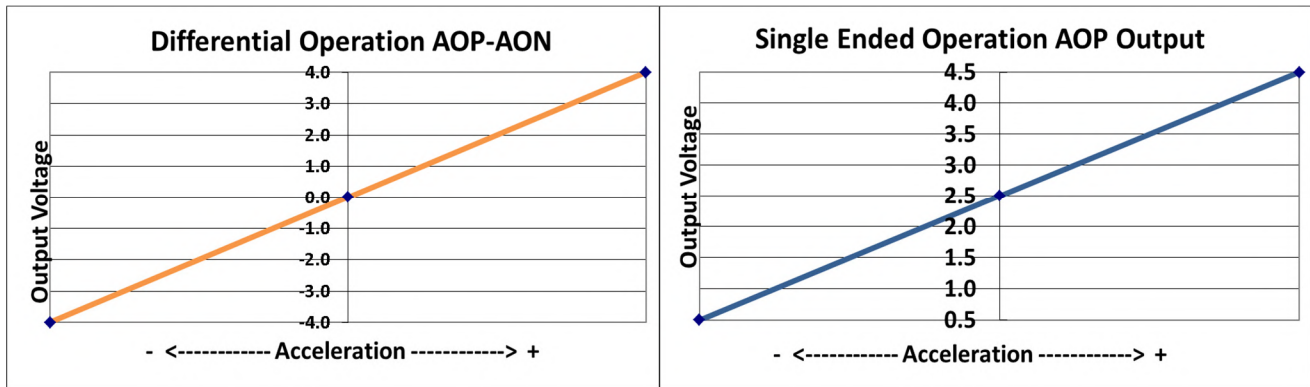

CABLE SPECIFICATIONS



2240: The connector shells, pins and sockets are gold plated brass. The 4PIN-CAB cable consists of four 30 AWG (7x38) silver-plated copper wires with PTFE insulation surrounded by a braided shield. The black FEP shield jacket has a nominal outer diameter of 0.100".

2480: The SDI Model 2480 has a 9-pin connector and only eight pins are used for the 8-wire cable; the 8PIN-CAB cable consists of eight 26 AWG tin-plated copper wires. All eight of the 26 AWG wires are covered by 8.5 mils of Teflon insulation.

Cables are available in five standard lengths, and custom lengths may be available for special order.

1-AIXS CABLE	3-AIXS CABLE	LENGTH - FEET	LENGTH - METERS (APPROXIMATE)
4PIN-CAB-04	8PIN-CAB-04	4 Feet	1.2 Meters
4PIN-CAB-10	8PIN-CAB-10	10 Feet	3 Meters
4PIN-CAB-20	8PIN-CAB-20	20 Feet	6 Meters
4PIN-CAB-33	8PIN-CAB-33	33 Feet	10 Meters
4PIN-CAB-50	8PIN-CAB-50	50 Feet	15.4 Meters

SPECIFICATIONS SUBJECT TO CHANGE WITHOUT NOTICE

CABLE LENGTH CONSIDERATIONS

Cable lengths of up to 50 feet (15 meters) can be used without the need to test for output instability. For cable lengths exceeding 50 feet, SDI recommends checking each individual installation for oscillation by tapping the accelerometer and watching the differential output for oscillation in the 20 kHz to 50 kHz region. If no oscillation is present, extended cable length should behave as expected. From the standpoint of output current drive and slew rate limitations, all SDI Universal Accelerometers are capable of driving over 2000 feet (600 meters) of cable. However, at some length ranging between 50 feet and 2000 feet, each device will likely begin to exhibit oscillation.

RECOMMENDED CONNECTIONS - DIFFERENTIAL

SDI Models 2240 and 2480 MEMS Specialty Hermetic Variable Capacitive Accelerometers provide optimal performance when they are connected to instrumentation in a differential configuration using both the AOP and AON output signals

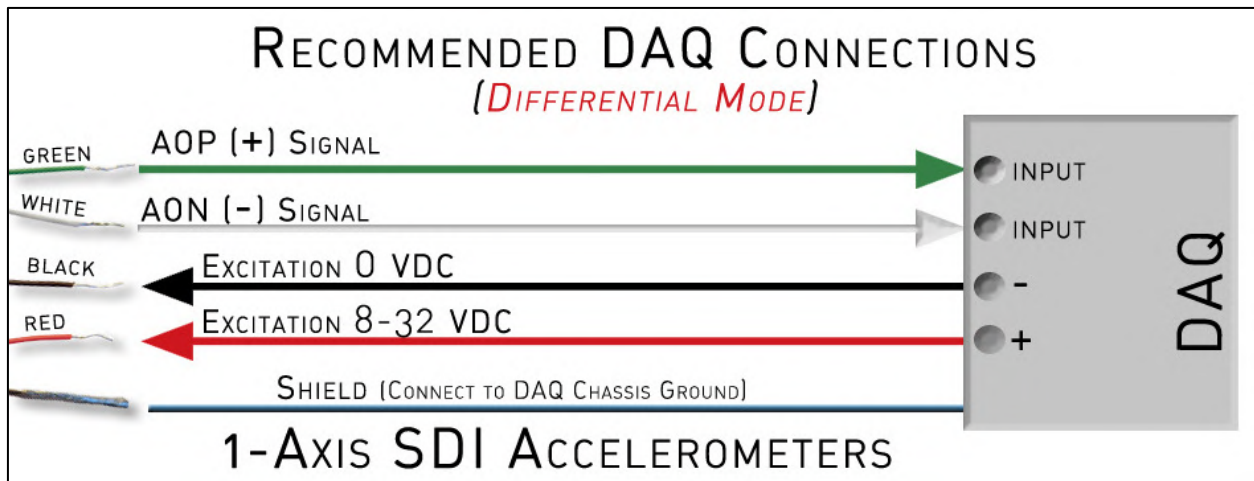
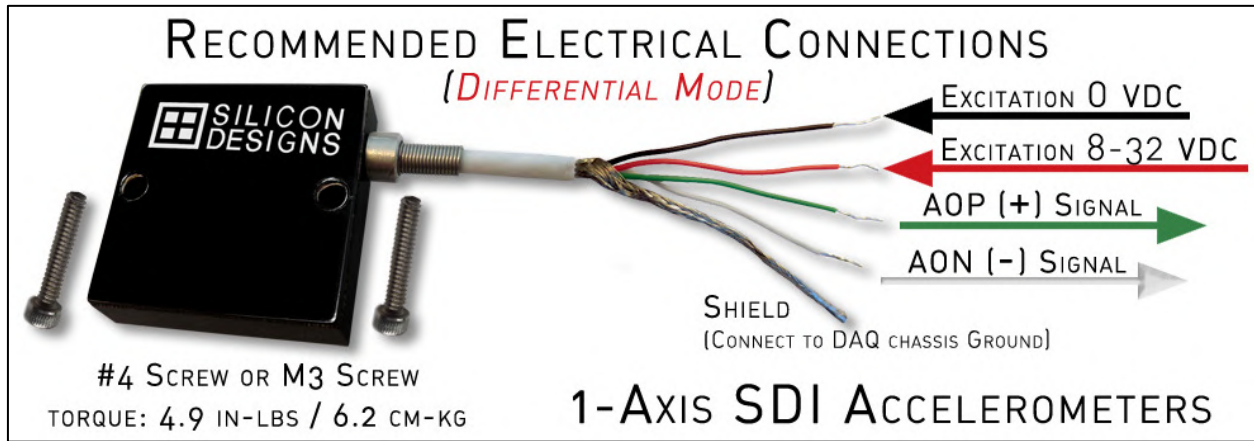

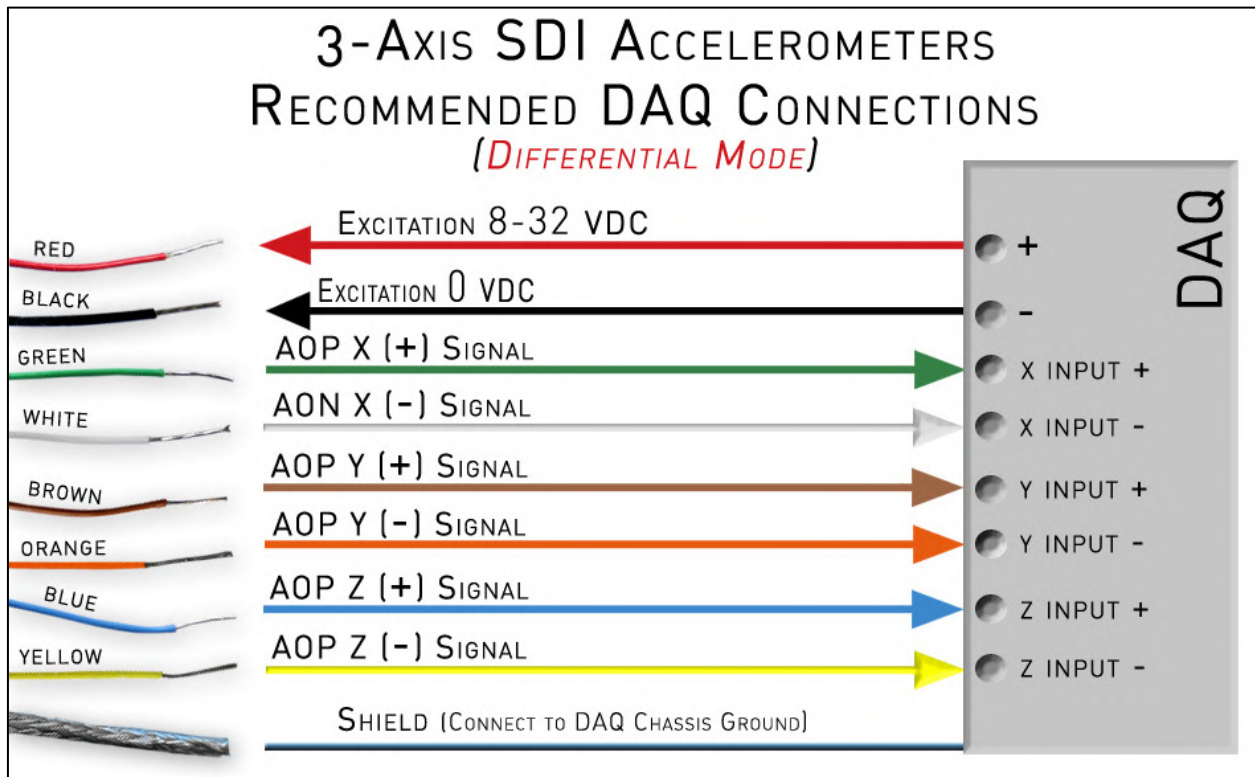
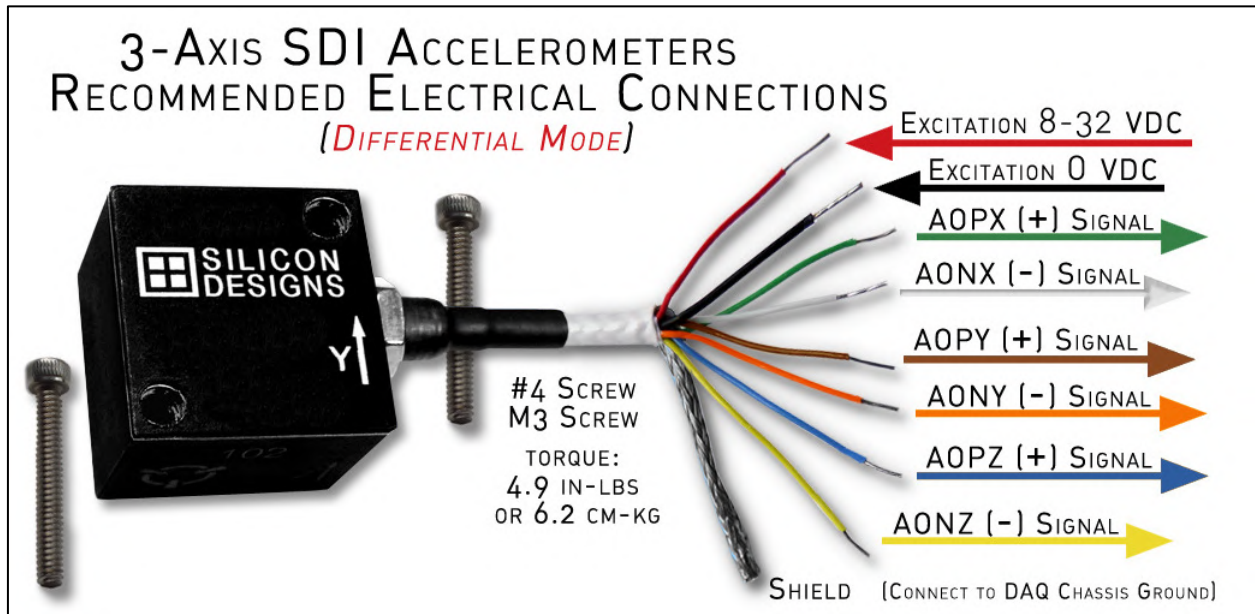

RECOMMENDED CONNECTIONS - SINGLE ENDED

Single ended operation is also possible with minor changes to the wiring configuration, as described below.

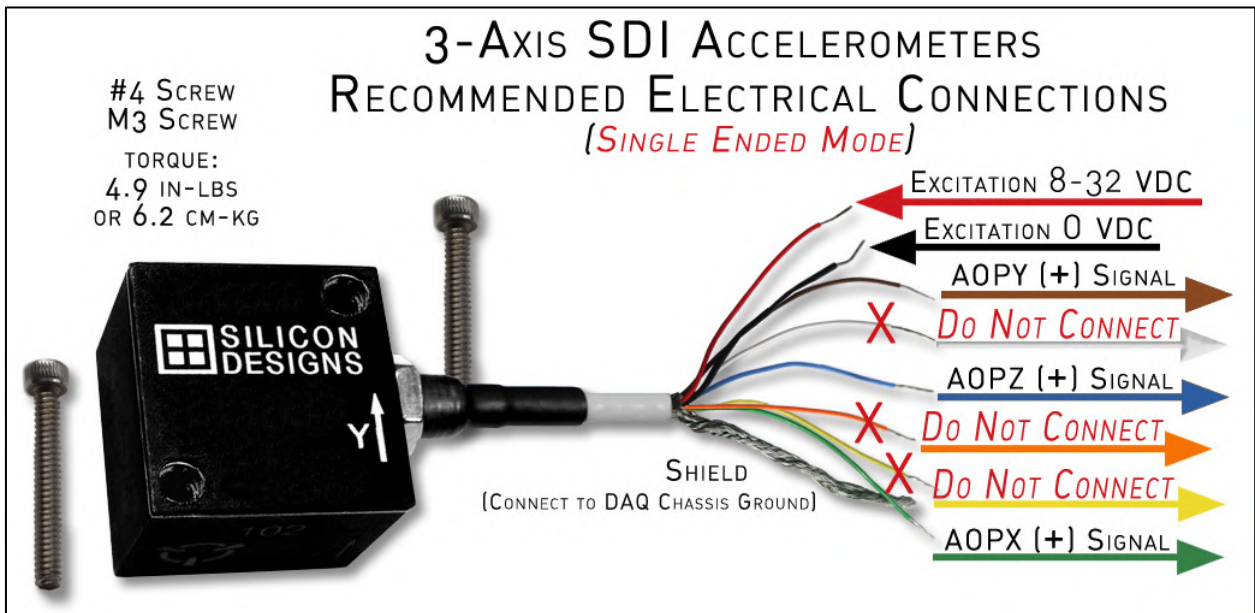
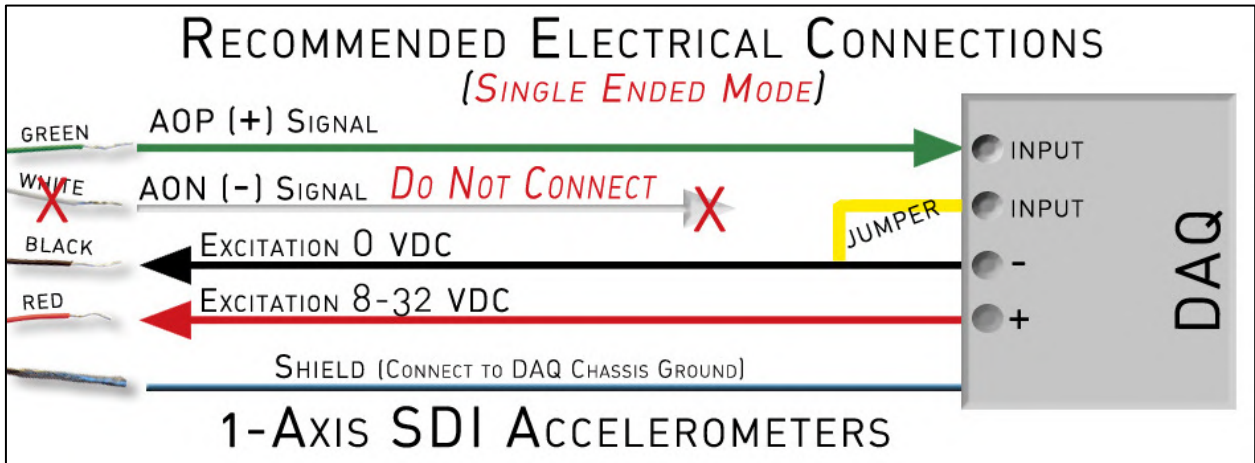
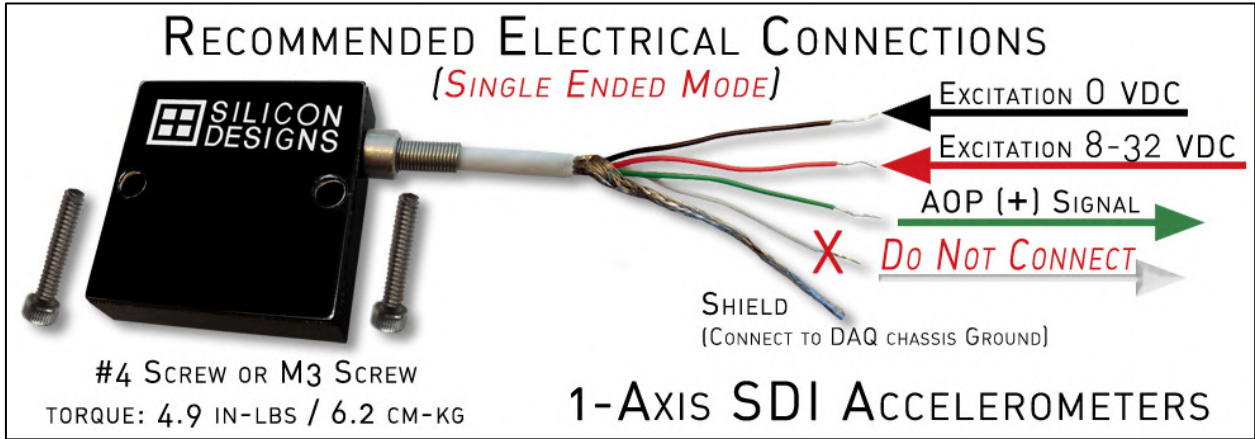

SPECIFICATIONS SUBJECT TO CHANGE WITHOUT NOTICE

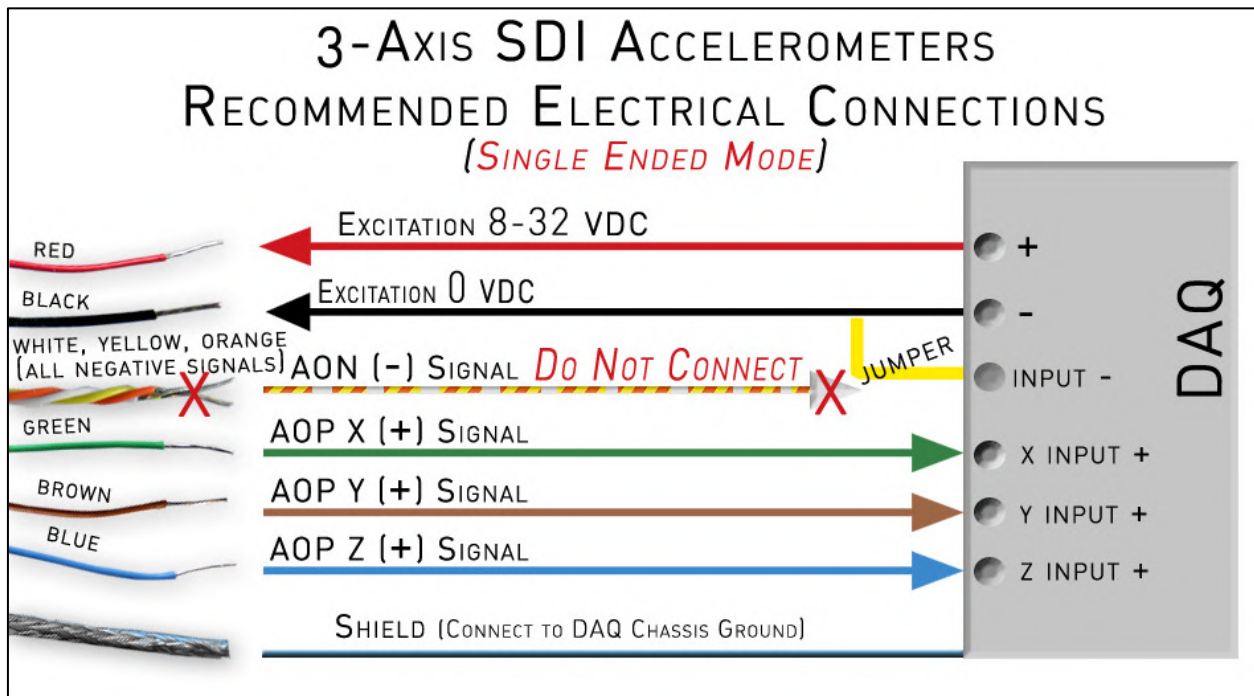

PACKAGE DIMENSIONS

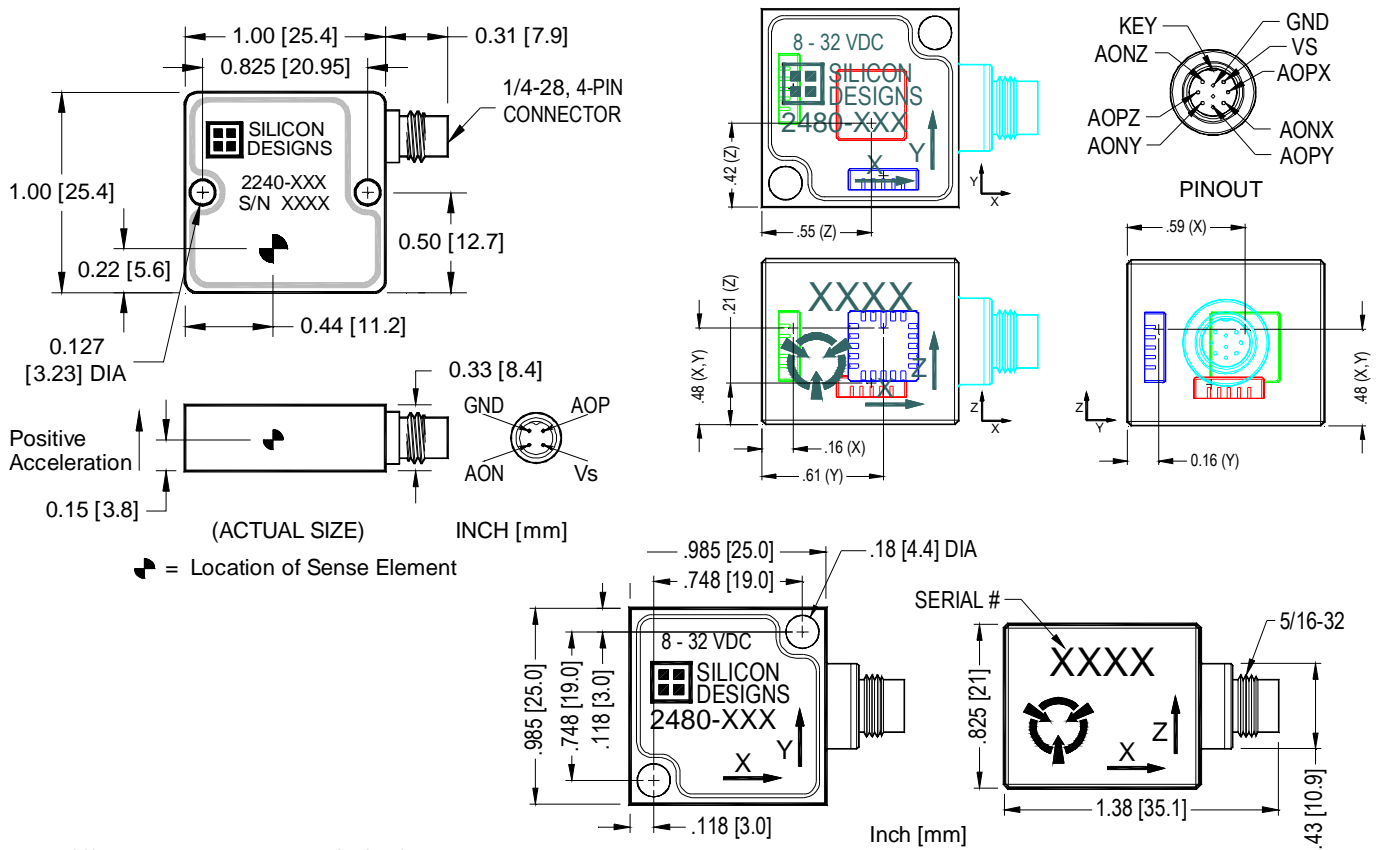



All measurements are in inches



Contact SDI for data sheets pertaining to 2240s with serial numbers below 3000 and 2480s with serial numbers below 195.

SPECIFICATIONS SUBJECT TO CHANGE WITHOUT NOTICE

COMPARABLE MODELS

SDI also produces non-hermetic accelerometer models with identical internal components in cost-effective anodized aluminum cases. Within these, customers can choose between an integrated 3' cable or an identical connector to those on the 2240 and 2480, allowing for interchangeable cables.

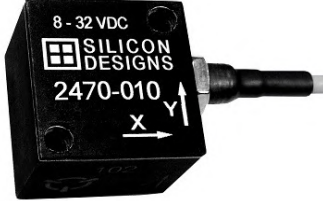
Hermetic Model	Alternative Model	Characteristics
2240 	2220 	<ul style="list-style-type: none"> Internally identical to 2240 Anodized aluminum case LxWxH Dimensions: 1" x 1" x 0.3" Integrated 3' cable with strain relief
	2276 	<ul style="list-style-type: none"> Same performance to 2240 in smaller package Anodized aluminum case LxWxH Dimensions: 1" x 0.63" x 0.425" Same connector as 2240 for interchangeable cables

Hermetic Model	Alternative Model	Characteristics
2480 	2470 	<ul style="list-style-type: none"> Internally identical to 2480 Anodized aluminum case LxWxH Dimensions: 1" x 1" x 0.825" Integrated 3' cable with strain relief
	2476 	<ul style="list-style-type: none"> Internally identical to 2480 Anodized aluminum case LxWxH Dimensions: 1" x 1" x 0.825" Same connector as 2480 for interchangeable cables

SPECIFICATIONS SUBJECT TO CHANGE WITHOUT NOTICE

**CALIBRATION REPORT EXAMPLES
LINEARITY, PHASE & FREQUENCY RESPONSE BY G-LEVEL**

The included calibration reports provide additional information about the linearity, output, phase, and frequency response as tested for each individual unit. The following are examples of the graphical data supplied on calibration reports, by G-level for the SDI Model 2480 Premium 3-axis accelerometer. The Single-Axis Model 2240's reports are similar but only display one (1) channel in the charts.

EXAMPLE 2G in 3-AXIS

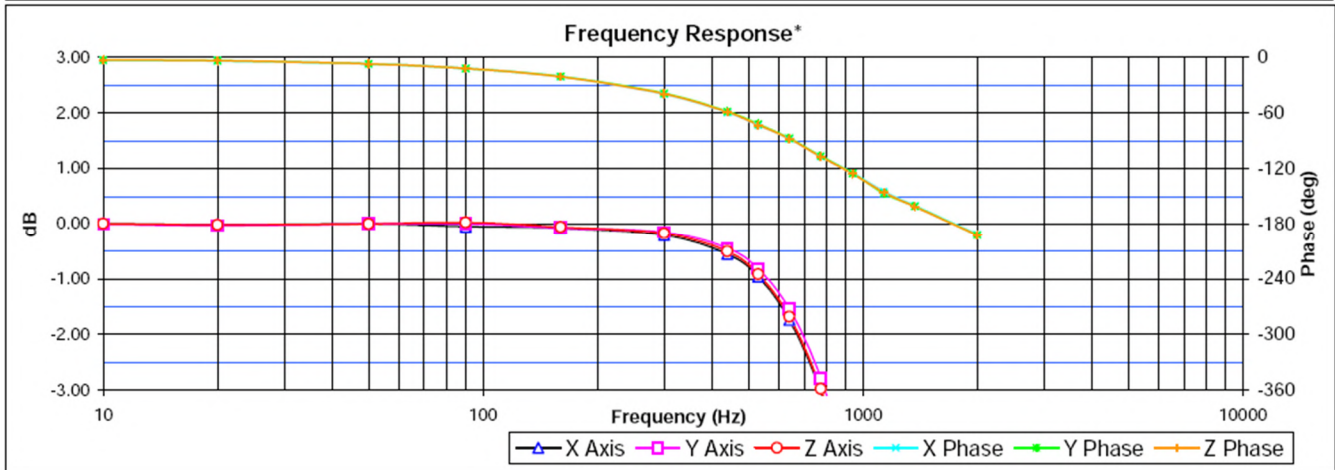
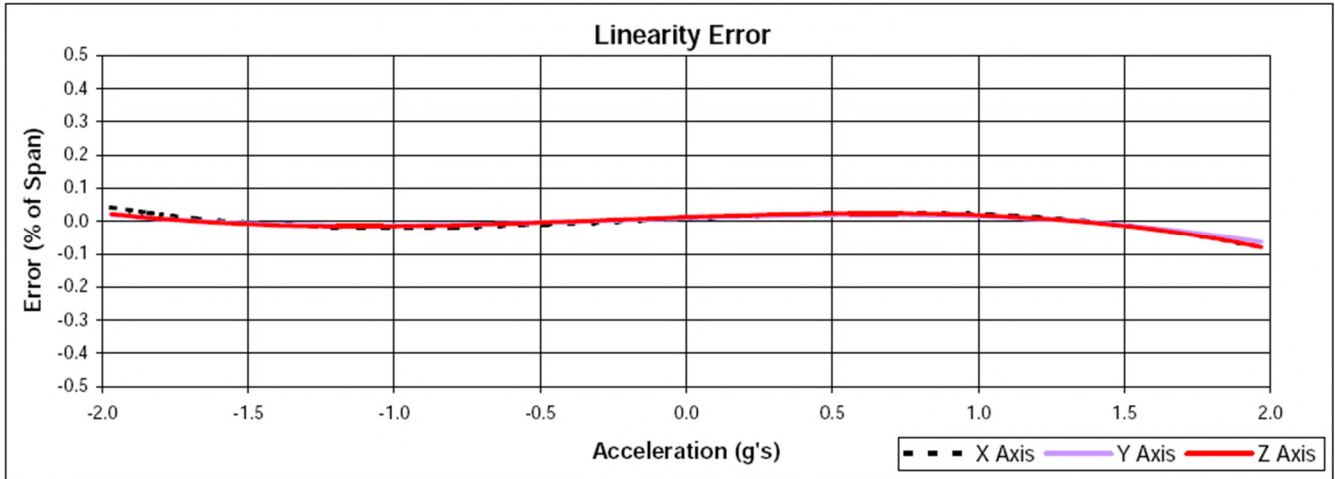

EXAMPLE 5G in 3-AXIS

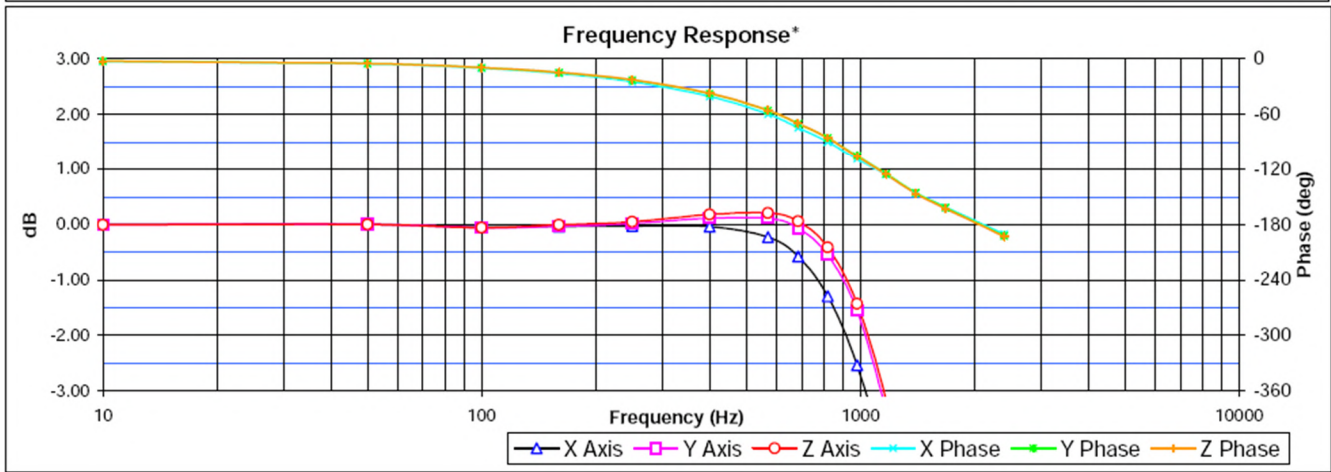
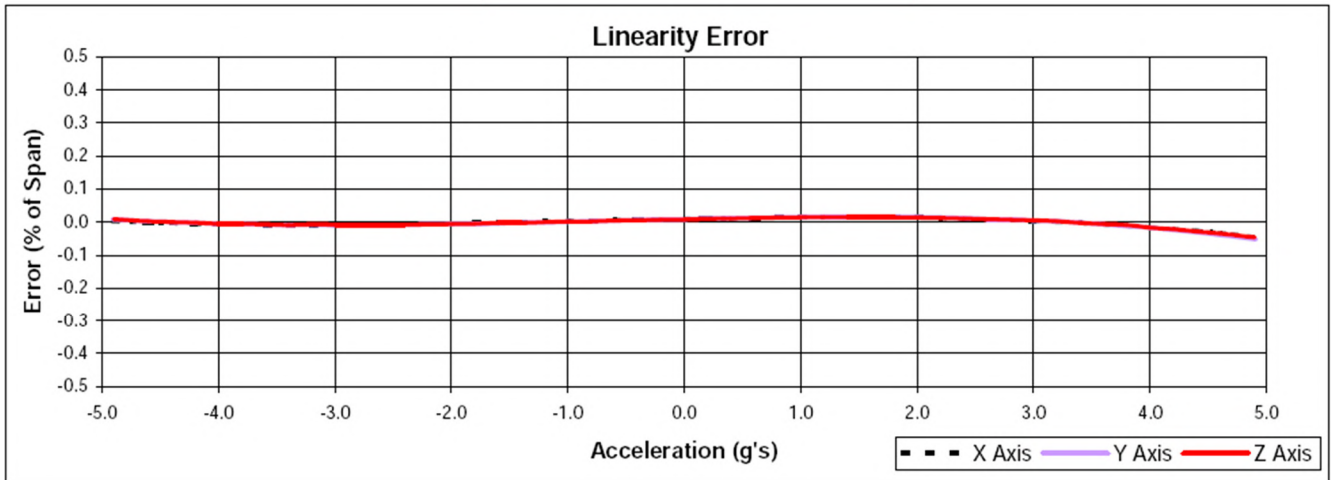

SPECIFICATIONS SUBJECT TO CHANGE WITHOUT NOTICE

EXAMPLE 10G in 3-AXIS

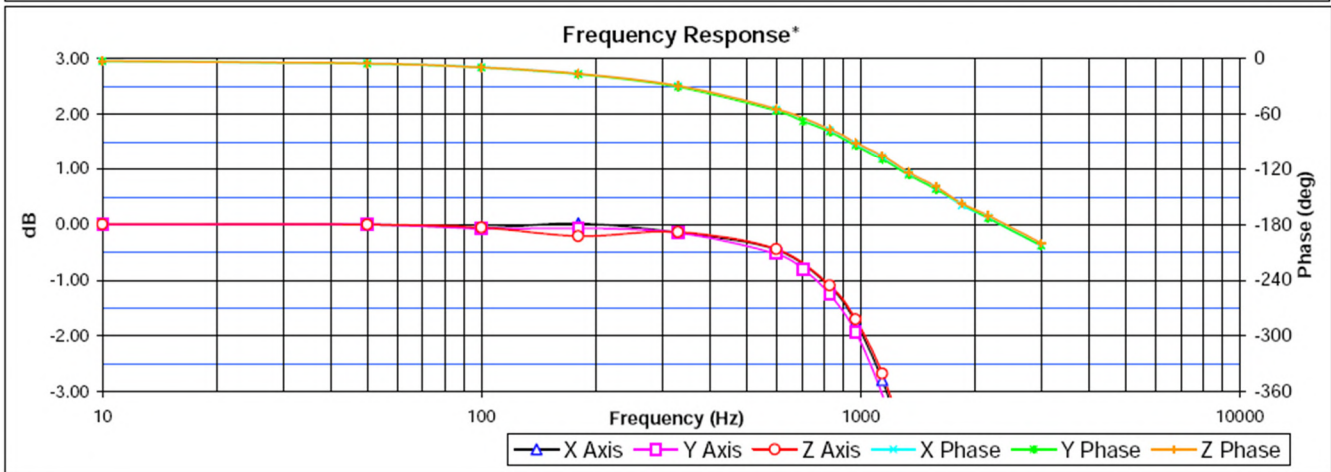
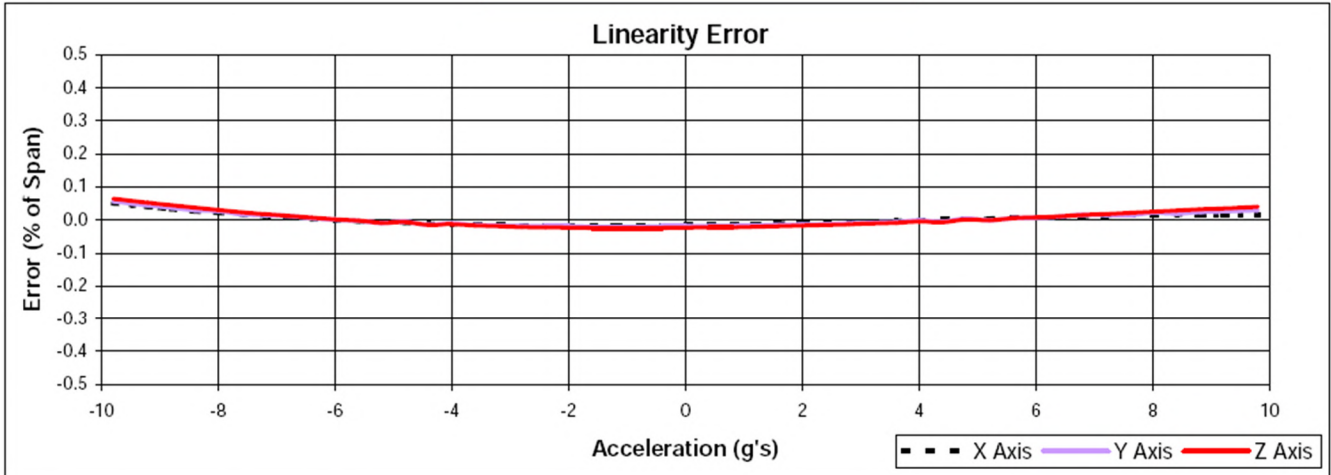

SPECIFICATIONS SUBJECT TO CHANGE WITHOUT NOTICE

EXAMPLE 25G in 3-AXIS

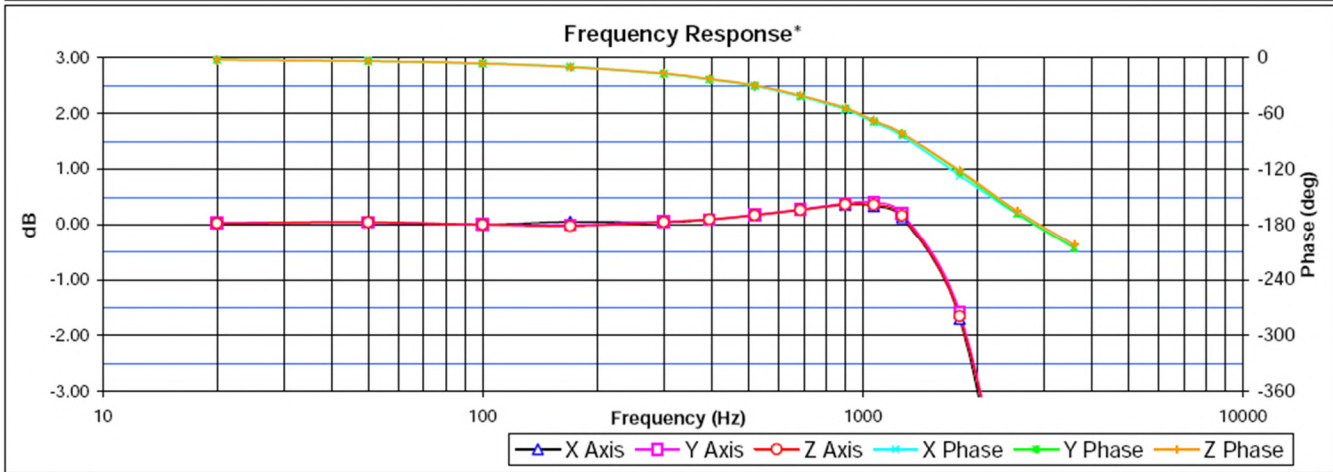
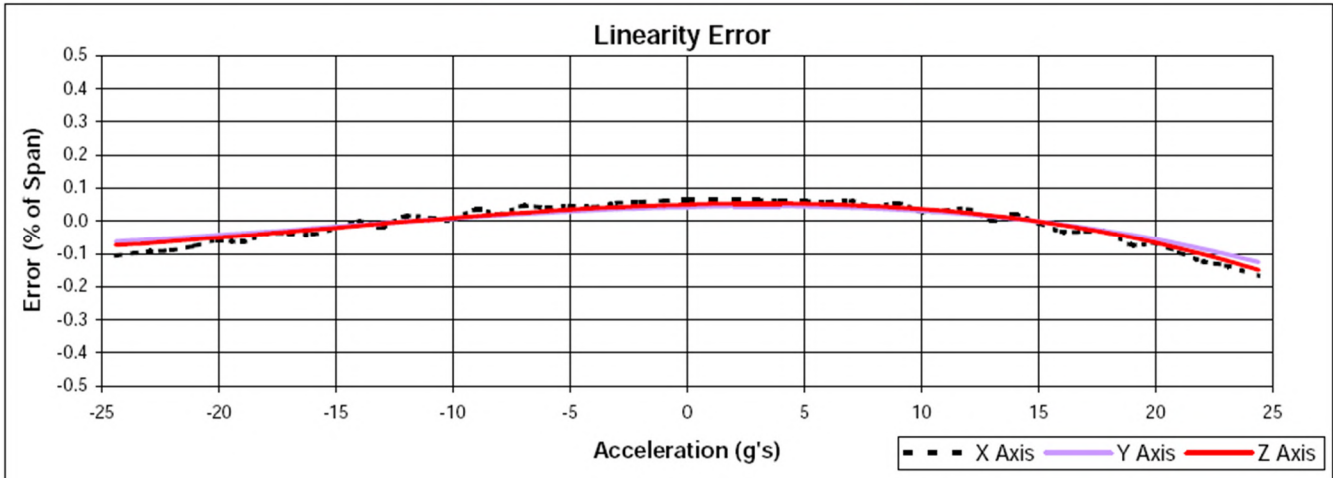

SPECIFICATIONS SUBJECT TO CHANGE WITHOUT NOTICE

EXAMPLE 50G in 3-AXIS

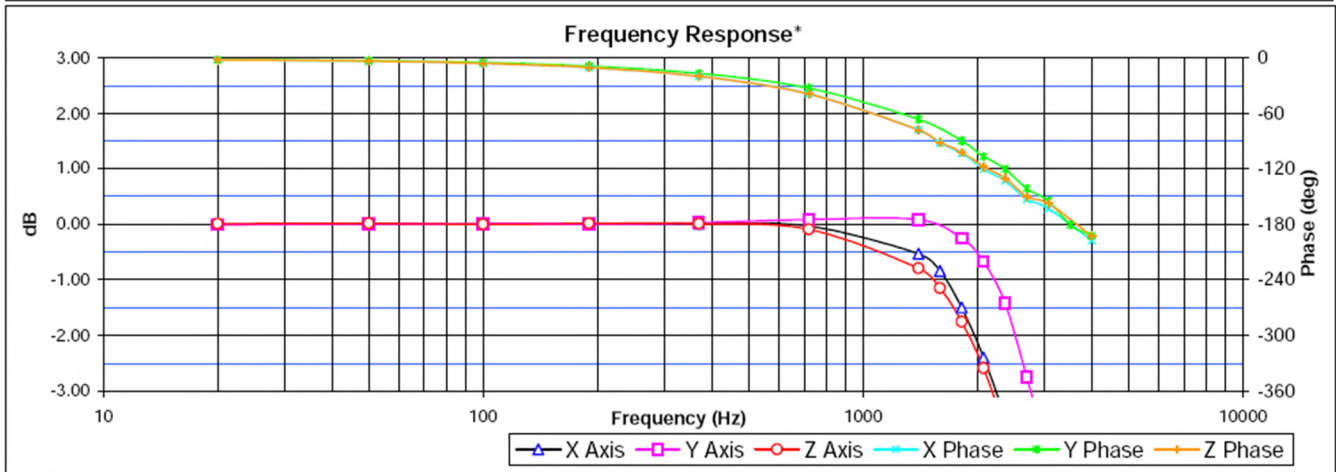
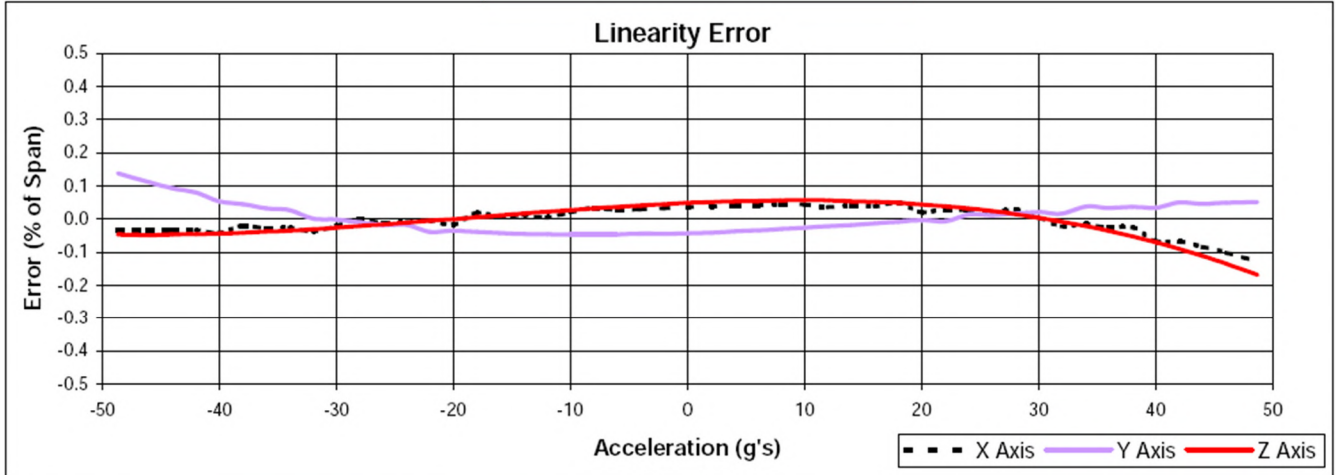

SPECIFICATIONS SUBJECT TO CHANGE WITHOUT NOTICE

EXAMPLE 100G in 3-AXIS

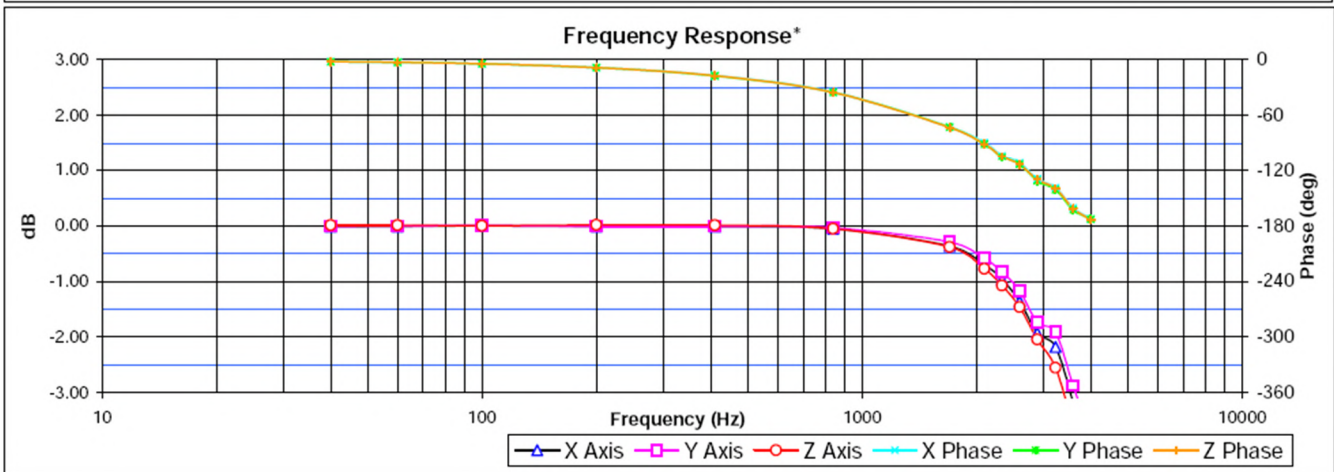
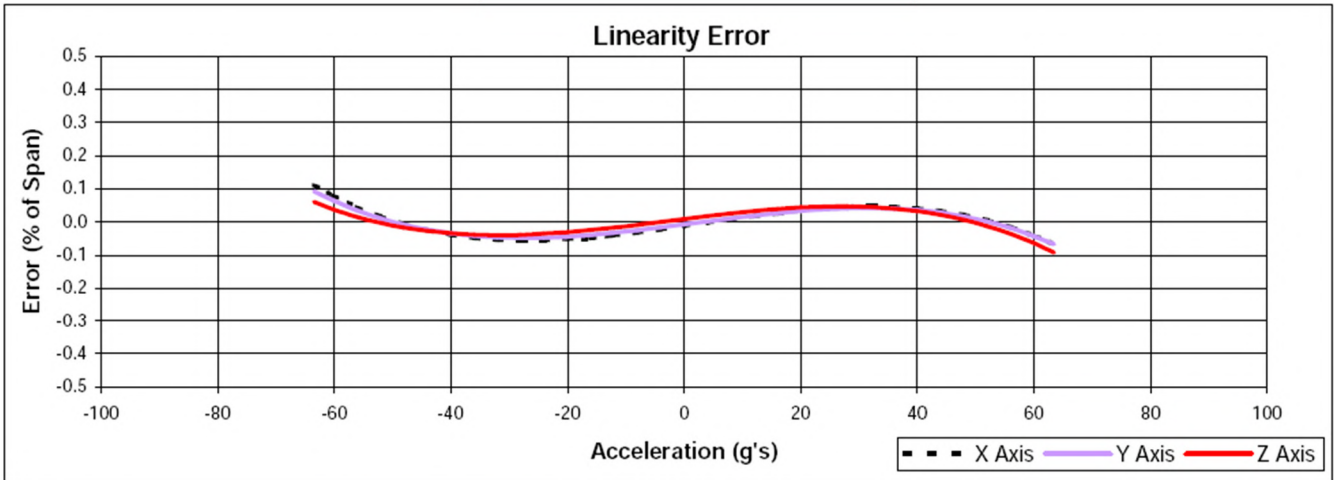

SPECIFICATIONS SUBJECT TO CHANGE WITHOUT NOTICE

EXAMPLE 200G in 3-AXIS

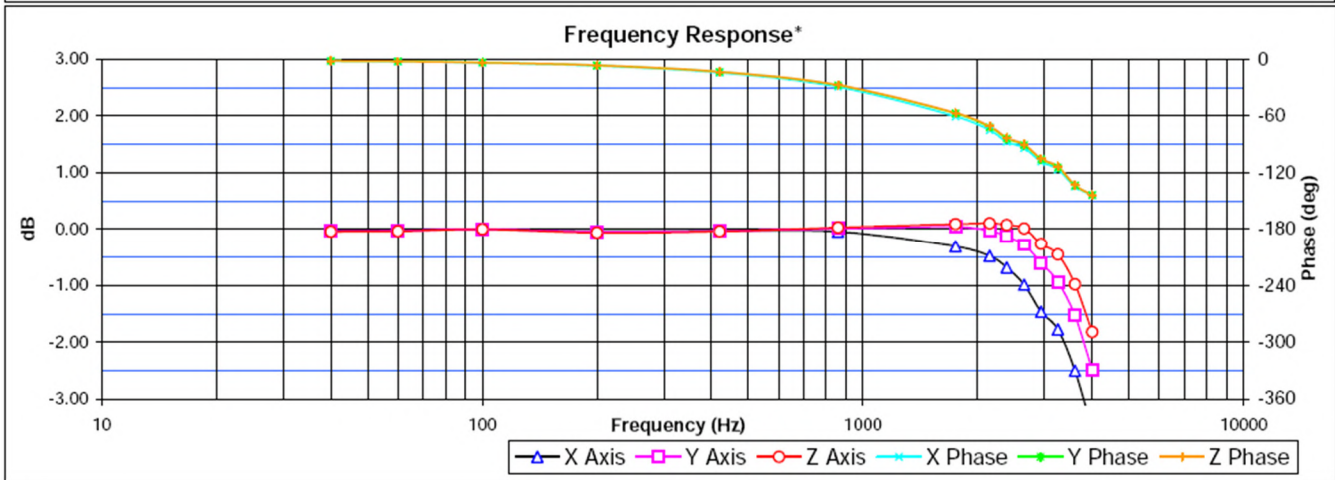
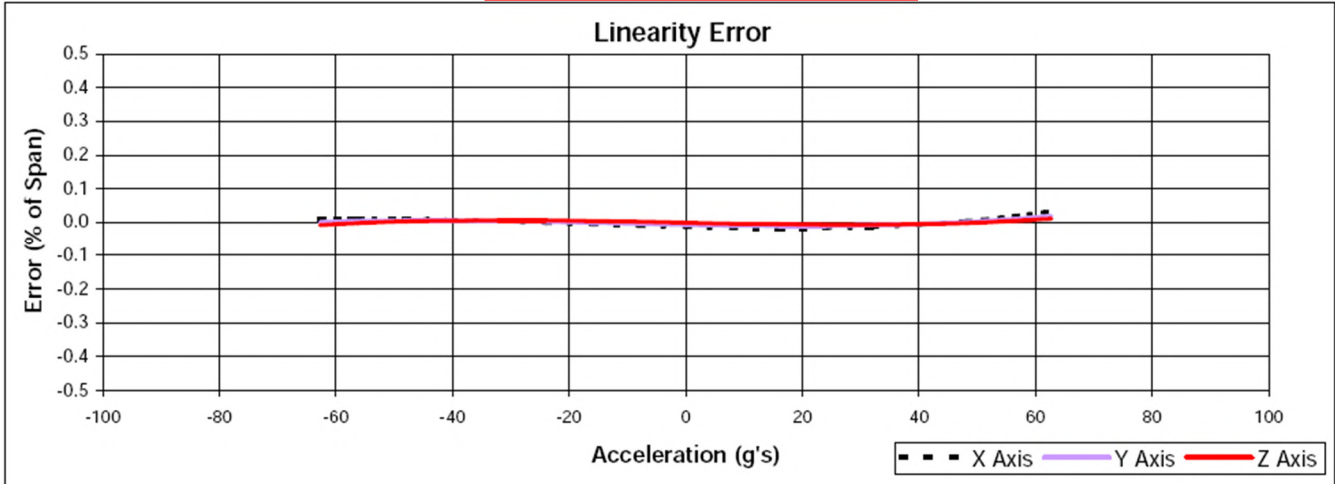

SPECIFICATIONS SUBJECT TO CHANGE WITHOUT NOTICE

EXAMPLE 400G in 3-AXIS

